

# THE EHRENFEST WIND-TREE MODEL: PERIODIC DIRECTIONS, RECURRENCE, DIFFUSION

PASCAL HUBERT, SAMUEL LELIÈVRE, AND SERGE TROUBETZKOY

ABSTRACT. We study periodic wind-tree models, unbounded planar billiards with periodically located rectangular obstacles. For a class of rational parameters we show the existence of completely periodic directions, and recurrence; for another class of rational parameters, there are directions in which all trajectories escape, and we prove a rate of escape for almost all directions. These results extend to a dense  $G_\delta$  of parameters.

## 1. INTRODUCTION

In 1912 Paul and Tatiana Ehrenfest proposed the wind-tree model of diffusion in order to study the statistical interpretation of the second law of thermodynamics and the applicability of the Boltzmann equation [EhEh]. In the Ehrenfest wind-tree model, a point (“wind”) particle moves on the plane and collides with the usual law of geometric optics with randomly placed fixed square scatterers (“tree”).

In this paper, we study periodic versions of the wind-tree model: the scatterers are identical rectangular obstacles located periodically along a square lattice on the plane, one obstacle centered at each lattice point. We call the subset of the plane obtained by removing the obstacles the billiard table (see some pictures in the appendix), even though it is a non compact space. Hardy and Weber [HaWe] have studied the periodic model, they proved recurrence and abnormal diffusion of the billiard flow for special dimensions of the obstacles and for very special directions, using results on skew products above rotations. In the general periodic case, the situation is much more difficult and, since this nice result, there has been no progress. In fact very few results are known for linear flows on translation surfaces of infinite area, or for billiards in irrational polygons from which they also arise (see however [DDL], [GuTr], [Ho], [HuWe], [Tr], [Tr1], [Tr2]).

---

*Date:* October 2, 2009.

*2000 Mathematics Subject Classification.* 30F30, 37E35, 37A40.

*Key words and phrases.* Billiards, periodic orbits, recurrence, diffusion, square-tiled surfaces.

**1.1. Statement of results.** Without loss of generality, we assume that the lattice is the standard  $\mathbb{Z}^2$ -lattice. We denote by  $a$  and  $b$  the dimensions of the rectangular obstacles, by  $T_{a,b}$  the corresponding billiard table, and by  $R^{i,j} = R_{a,b}^{i,j}$  the rectangle centered at the lattice point of coordinates  $(i, j) \in \mathbb{Z}^2$ . The set of billiard tables under study is hence parametrized by  $(a, b)$  in the noncompact parameter space  $\mathcal{X} = (0, 1)^2$ .

We define a dense subset of parameter values:

$$\mathcal{E} = \left\{ (a, b) = (p/q, r/s) \in \mathbb{Q} \times \mathbb{Q} : \begin{array}{l} (p, q) = (r, s) = 1, \quad 0 < p < q, \quad 0 < r < s, \\ p, r \text{ odd}, \quad q, s \text{ even} \end{array} \right\}.$$

Given a flow  $\Phi$  acting on a measured topological space  $(\Omega, \mu)$ , a point  $x \in \Omega$  is *recurrent* for  $\Phi$  if for every neighborhood  $U$  of  $x$  and any  $T_0 > 0$  there is a time  $T > T_0$  such that  $\Phi_T(x) \in U$ ; the flow  $\Phi$  itself is *recurrent* if almost every point (with respect to  $\mu$ ) is recurrent.

In our setting, the billiard flow  $\phi^\theta$  is the flow at constant unit speed in direction  $\theta$ , bouncing off at equal angles upon hitting the rectangular obstacles. Regular trajectories are those which never hit a corner (where the billiard flow is undefined). In the whole paper, *direction* is to be understood as *slope*. We prove the following results:

**Theorem 1.** *If the rectangular obstacles have dimensions  $(a, b) \in \mathcal{E}$ , then, for the billiard table  $T_{a,b}$ :*

- *there is a subset  $P$  of  $\mathbb{Q}$ , dense in  $\mathbb{R}$ , such that every regular trajectory starting with direction in  $P$  is periodic;*
- *for almost every direction, the billiard flow is recurrent with respect to the natural phase volume.*

Since  $\mathcal{E}$  is countable, the set of directions of full measure in the last statement can even be chosen independent of the parameter  $(a, b) \in \mathcal{E}$ .

For  $j \in \mathbb{N}$  denote by  $\log_j$  the  $j$ -th iterate of the logarithm function, i.e.,  $\log_j = \log \circ \dots \circ \log$  ( $j$  times).

Setting different parity conditions and defining

$$\mathcal{E}' = \left\{ (a, b) = (p/q, r/s) \in \mathbb{Q} \times \mathbb{Q} : \begin{array}{l} (p, q) = (r, s) = 1, \quad 0 < p < q, \quad 0 < r < s, \\ p, r \text{ even}, \quad q, s \text{ odd} \end{array} \right\},$$

we have

**Theorem 2.** *If the rectangular obstacles have dimensions  $(a, b) \in \mathcal{E}'$ , then, for the billiard table  $T_{a,b}$ :*

- there is no direction  $\alpha \in \mathbb{Q}$  such that all regular trajectories starting with direction  $\alpha$  are periodic;
- there is a subset  $P$  of  $\mathbb{Q}$ , dense in  $\mathbb{R}$ , such that no trajectory starting with direction in  $P$  is periodic;
- $\forall k \geq 1$ , for a.e.  $\theta$ ,  $\limsup_{t \rightarrow \infty} \frac{\text{dist}(\phi_t^\theta x, x)}{\prod_{j=1}^k \log_j t} = \infty$  almost surely.

As a corollary, we obtain a result for a dense  $G_\delta$  of parameters in  $\mathcal{X}$ :

**Corollary 3.** *Consider any closed  $\mathcal{Y} \subset \mathcal{X}$  for which  $\mathcal{E} \cap \mathcal{Y}$  and  $\mathcal{E}' \cap \mathcal{Y}$  are dense in  $\mathcal{Y}$ . Then there is a residual set  $G \subset \mathcal{Y}$  such that, for each  $(a, b) \in G$ ,*

- the billiard flow on  $T_{a,b}$  is recurrent;
- the set of periodic points is dense in the phase space of  $T_{a,b}$ ;
- $\forall k \geq 1$ , for a.e.  $\theta$ ,  $\limsup_{t \rightarrow \infty} \frac{\text{dist}(\phi_t^\theta x, x)}{\prod_{j=1}^k \log_j t} = \infty$  almost surely.

The results of Theorems 1 and 2 can be rephrased (and sharpened) in terms of translation surfaces. By a standard construction consisting in unfolding the trajectories, the billiard flow in a given direction is replaced by a linear flow on a translation surface  $X_{a,b}$  (of infinite area). This translation surface of infinite area is a  $\mathbb{Z}^2$ -covering of a finite-degree covering of a (finite-area) compact translation surface  $Y_{a,b}$  of genus 2 with one singular point, which is square-tiled when  $a$  and  $b$  are rational.

We use the same notation  $\phi_t^\theta$  for the linear flow in direction  $\theta$  on  $X_{a,b}$  or  $Y_{a,b}$  as for the billiard flow in direction  $\theta$  on  $T_{a,b}$ . The flow  $\phi_t^\theta$ , or the direction  $\theta$ , is called *completely periodic* if every regular trajectory in direction  $\theta$  is closed; note that a given direction could be completely periodic for  $Y_{a,b}$  while not for  $X_{a,b}$ . The flow  $\phi_t^\theta$ , or the direction  $\theta$ , is called *strongly parabolic* if in addition  $X_{a,b}$  decomposes into an infinite number of cylinders isometric to each other.

**Theorem 4.** *For rectangular obstacles with dimensions  $(a, b) \in \mathcal{E}$ :*

- the set  $P \subset \mathbb{Q}$  of strongly parabolic directions for  $X_{a,b}$  is dense in  $\mathbb{R}$ .
- in almost every direction, the linear flow on  $X_{a,b}$  is recurrent.

*Remark 5.* When  $a = b = 1/2$ , strongly parabolic directions are exactly the rational directions  $u/v$  such that  $u$  and  $v$  are both odd, and they are the only completely periodic directions.

**Theorem 6.** *For rectangular obstacles with dimensions  $(a, b) \in \mathcal{E}'$ :*

- there are no completely periodic directions on  $X_{a,b}$ ;

- there is a subset  $P'$  of  $\mathbb{Q}$ , dense in  $\mathbb{R}$ , of directions in which the linear flow on  $Y_{a,b}$  is completely periodic with one cylinder, and thus there are no periodic orbits on  $X_{a,b}$  in these directions;
- on  $X_{a,b}$ ,  $\forall k \geq 1$ , for a.e.  $\theta$ ,  $\limsup_{t \rightarrow \infty} \frac{\text{dist}(\phi_t^\theta x, x)}{\prod_{j=1}^k \log_j t} = \infty$  almost surely.

*Remark 7.* In Theorem 2, Corollary 3 and Theorem 6, we suspect that the function  $\prod_{j=1}^k \log_j$  could be replaced by a faster-growing function, such as possibly  $t \mapsto t^\lambda$  for a suitable  $\lambda$ .

**1.2. Reader's guide.** Our approach is based on results on compact translation surfaces. The fundamental paper of Veech [Ve] was the inspiration for many papers about Veech surfaces and (compact) square-tiled surfaces, for which the situation is particularly well understood in genus two.

If  $(a, b) \in \mathcal{E}$ , we remark that some 'good' one-cylinder directions on  $Y_{a,b}$  are strongly parabolic directions for  $X_{a,b}$ . This is our main statement. This relies on a careful study of the Weierstrass points on  $Y_{a,b}$  developed by McMullen (see [Mc]). From there, good Diophantine approximation of almost every irrational number by these periodic directions (due to the fact that the set of good one-cylinder directions contains the orbit of a cusp of a Fuchsian group of finite covolume) implies the recurrence of the flow for almost every direction when  $(a, b) \in \mathcal{E}$ . Similar arguments hold when  $(a, b) \in \mathcal{E}'$ . Using a standard trick in billiard theory, we get Corollary 3.

**1.3. Acknowledgments.** We thank C. McMullen for showing us how to give a good definition of the set  $\mathcal{E}$ . We thank F. Paulin who explained to us the part concerning diophantine approximation. We also thank F. Valdez for helpful discussions concerning the definition of a non compact translation surface. We would like to thank the referee for a careful reading of the manuscript and useful remarks.

The first and second authors are partially supported by Projet blanc ANR: ANR-06-BLAN-0038.

## 2. BACKGROUND

**2.1. Translation surfaces.** In this section, we briefly introduce the basic notions of Teichmüller dynamics. For more on translation surfaces, see for instance [MaTa], [Vi], [Zo].

A surface is called a *translation surface* if it can be obtained by edge-to-edge gluing of polygons in the plane, only using translations

(the polygons need not be compact or finitely many but should be at most countably many, and the lengths of sides and diagonals should be bounded away from zero). The translation structure induces a flat metric with conical singularities. Note that if the gluings produce an infinite angle at some vertex, no neighborhood of this vertex is homeomorphic to an open set in the plane, so that with this point the resulting object cannot properly be called a surface; however this does not occur in this paper. A discussion about singularities on non compact translation surfaces can be found in [Bo].

A *saddle connection* is a geodesic segment for the flat metric starting and ending at a singularity, and containing no singularity in its interior.

A *cylinder* on a translation surface is a maximal connected union of homotopic simple closed geodesics. If the surface is compact and the genus is greater than one then every cylinder is bounded by saddle connections. A cylinder has a length (or circumference)  $c$  and a height  $h$ . The *modulus* of a cylinder is  $\mu = h/c$ .

On a noncompact translation surface, a *strip* is a maximal connected union of parallel biinfinite geodesics.

On a compact translation surface, a direction  $\theta$  is called *periodic* if the translation surface is the union of the closures of cylinders in this direction, and *parabolic* if moreover the moduli of all the cylinders are commensurable.

On a translation surface, a direction  $\theta$  is *strongly parabolic* if the surface is the union of closed cylinders in this direction and the cylinders are isometric to each other.

On a polygonal billiard, the *combinatorial length* of a portion of trajectory is the number of collisions it makes.

**2.2. Square-tiled surfaces.** A *square-tiled surface* is a translation surface obtained by edge-to-edge gluing of unit squares. Consequently it is a covering of the torus  $\mathbb{R}^2/\mathbb{Z}^2$  ramified only over the origin. A square-tiled surface is *primitive* if the lattice generated by the vectors of saddle connections is equal to  $\mathbb{Z}^2$ . Abusing notations, we will call square-tiled a translation surface obtained by gluing copies of a fixed rectangle instead of squares. We recall that on a compact square-tiled surface, a direction has rational slope if and only if it is periodic if and only if it is parabolic. A theorem by Veech implies that on a compact square-tiled surface, every irrational direction is minimal and uniquely ergodic [Ve].

**2.3. Genus 2 surfaces, L-shaped surfaces.** For finite area translation surfaces, the angles around the singularities are multiples of  $2\pi$ . The family of these integers is the combinatorics of the surface. The

moduli space of translation surfaces with fixed combinatorics is called a *stratum*. In genus 2, there are 2 strata. One of them is made of surfaces with one singularity of angle  $6\pi$ ; it is called  $\mathcal{H}(2)$ . The other one is made of surfaces with two singularities of angle  $4\pi$ ; it is called  $\mathcal{H}(1, 1)$ . Every genus 2 translation surface is hyperelliptic.

An L-shaped surface  $L(\alpha, \beta, \gamma, \delta)$  is a translation surface defined by 4 parameters: the lengths of the horizontal saddle connections  $\alpha$ ,  $\gamma$  and the lengths of the vertical saddle connections  $\beta$ ,  $\delta$ , see Figure 1, where segments with same labels are glued together. An L-shaped surface belongs to the stratum  $\mathcal{H}(2)$ . Its six Weierstrass points are depicted on Figure 2. When the parameters  $\alpha, \beta, \gamma, \delta$  are rational, it is a square-tiled surface.

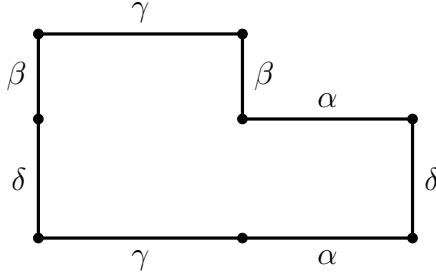

FIGURE 1. L-shaped surface

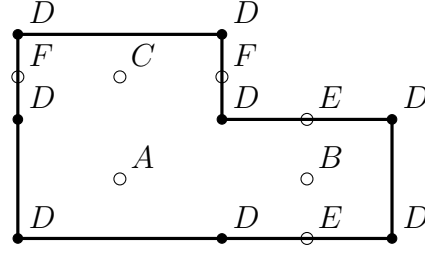

FIGURE 2. Weierstrass points

The position of Weierstrass points with respect to the squares that tile the surface may be among the following: corners, centers, midpoints of horizontal or vertical edges. When a Weierstrass point is located at a corner, we call it an *integer Weierstrass point*.

The action of  $SL_2(\mathbb{Z})$  (see the following subsection) on primitive square-tiled surfaces in  $\mathcal{H}(2)$  preserves the number of integer Weierstrass points. This provides an invariant distinguishing between  $SL_2(\mathbb{Z})$  orbits of primitive square tiled surfaces in  $\mathcal{H}(2)$  (see [HuLe], [Mc]). If the number of squares is odd and at least 5, there are two orbits: in one orbit (orbit *A*) the surfaces have 1 integer Weierstrass point (the singularity); in the other one (orbit *B*), there are 3 integer Weierstrass points. In the proof of Lemma 8, we will use an a priori finer invariant introduced by Kani (see [Ka1], [Ka2]).

**2.4. Veech groups.** Given any translation surface  $(X, \omega)$ , an *affine diffeomorphism* is an orientation preserving homeomorphism of  $X$  that permutes the singularities of the flat metric and acts affinely on the polygons defining  $X$ . The group of affine diffeomorphisms is denoted

by  $\text{Aff}(X, \omega)$ . The image of the derivation map

$$d : \begin{cases} \text{Aff}(X, \omega) \rightarrow \text{GL}_2(\mathbb{R}) \\ f \mapsto df \end{cases}$$

is called the *Veech group*, and denoted by  $\text{SL}(X, \omega)$ . If  $(X, \omega)$  is a compact translation surface, then  $\text{SL}(X, \omega)$  is a Fuchsian group (discrete subgroup of  $\text{SL}_2(\mathbb{R})$ ). If  $(X, \omega)$  is a primitive square-tiled surface then its Veech group is a subgroup of  $\text{SL}_2(\mathbb{Z})$ , for the following reason. First of all, an affine diffeomorphism sends a saddle connection to a saddle connection, thus it sends the standard basis of  $\mathbb{R}^2$  to vectors with integer coordinates. Thus, elements of  $\text{SL}(X, \omega)$  have integral entries. By the same reasoning, the inverse of such element has also integer entries and thus  $\text{SL}(X, \omega)$  is a subgroup of  $\text{SL}_2(\mathbb{Z})$ .

For surfaces in  $\mathcal{H}(2)$ , the affine group is isomorphic to the Veech group (see for instance Proposition 4.4 in [HuLe]).

**2.5. Construction of  $X_{a,b}$ .** Label each rectangular obstacle by the element of  $\mathbb{Z}^2$  giving its position. Its four sides are  $\ell$  (left),  $r$  (right),  $b$  (bottom),  $t$  (top). We recall the classical construction of a translation surface from a polygonal billiard. The idea is to unfold the trajectories and to reflect the table. To get the surface  $X_{a,b}$ , we need four copies of the billiard table  $T_{a,b}$  because the angles of the table are multiples of  $\pi/2$ . We label the copies by *I, II, III, IV*.

The following sides are glued together (see Figure 3), for all couples  $(m, n) \in \mathbb{Z}^2$ :

- $(\ell, (m, n), I)$  is identified with  $(r, (-m, n), II)$
- $(r, (m, n), I)$  is identified with  $(\ell, (-m, n), II)$
- $(b, (m, n), I)$  is identified with  $(t, (m, -n), III)$
- $(t, (m, n), I)$  is identified with  $(b, (m, -n), III)$
- $(\ell, (m, n), III)$  is identified with  $(r, (-m, n), IV)$
- $(r, (m, n), III)$  is identified with  $(\ell, (-m, n), IV)$
- $(b, (m, n), II)$  is identified with  $(t, (m, -n), IV)$
- $(t, (m, n), II)$  is identified with  $(b, (m, -n), IV)$

The surface  $X_{a,b}$  obtained this way has no boundary, infinite area and infinite genus.

### 3. PROOF OF THEOREM 4

We prove Theorem 4 and note that Theorem 1 follows immediately.

**3.1. Construction of a finite area square-tiled surface.** Given  $a, b \in (0, 1)$ , we construct the following (finite area) translation surface. A fundamental domain is  $[0, 1] \times [0, 1] \setminus [(1-a)/2, (1+a)/2] \times [(1-$

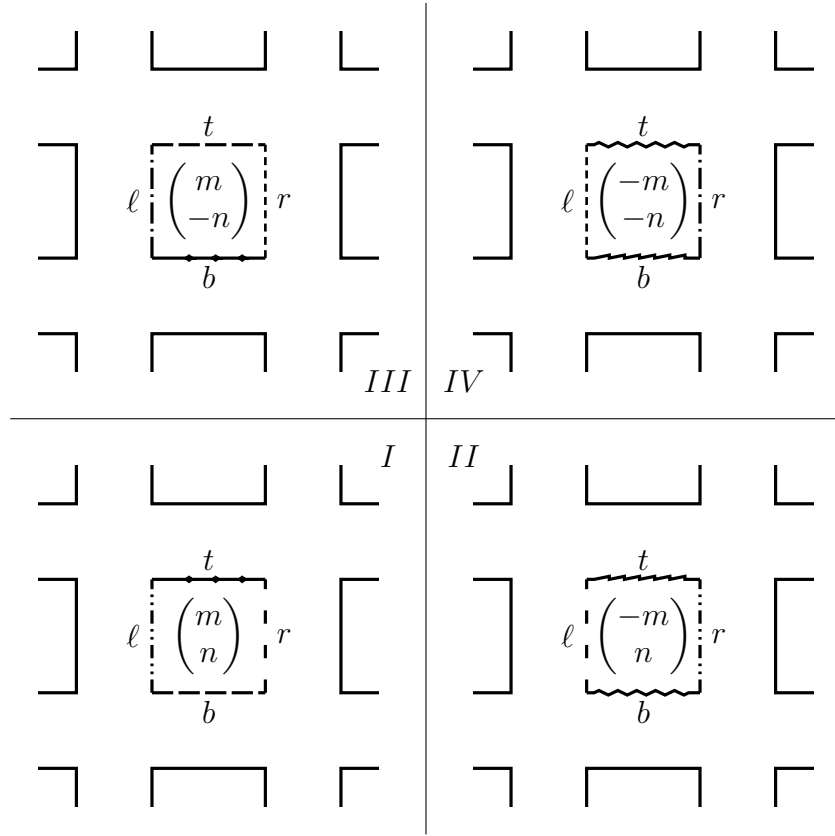
FIGURE 3. Side-pairings for  $X_{a,b}$ 

$b)/2, (1 + b)/2]$ . Parallel sides of the same length are identified (see Figure 4). We denote this surface by  $Y_{a,b}$ .  $Y_{a,b}$  is a surface of genus two with one conical point with angle  $6\pi$ . It belongs to the stratum  $\mathcal{H}(2)$ .  $Y_{a,b}$  is a quotient of  $X_{a,b}$ . We denote by  $\pi$  the projection from  $X_{a,b}$  to  $Y_{a,b}$ . We are going to derive properties of the linear flows on  $X_{a,b}$  from results on square-tiled surfaces in  $\mathcal{H}(2)$ . The surface  $Y_{a,b}$  is an L-shaped surface of parameters  $(1 - a, a, 1 - b, b)$ . The 6 Weierstrass points are  $A, B, C, D, E, F$  on Figure 2. When  $a$  and  $b$  are rational, it is a square-tiled surface (in fact, it is tiled by small rectangles).

### 3.2. Good one-cylinder directions on square-tiled surfaces in $\mathcal{H}(2)$ .

We recall that a translation surface in  $\mathcal{H}(2)$  is hyperelliptic. McMullen [Mc] proved (see Hubert-Lelièvre [HuLe] for earlier results) that every square-tiled surface in  $\mathcal{H}(2)$  contains a one-cylinder direction. Here, we need more, and we will use the following lemma.

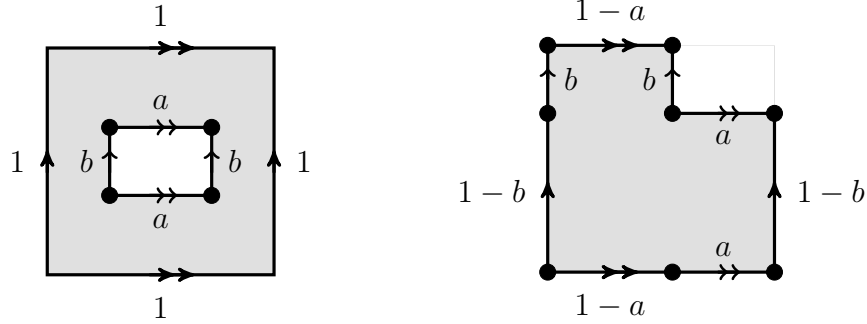

FIGURE 4. Finite area surface  $Y_{a,b}$ : two views. Either cut out a rectangle of dimensions  $a \times b$  from a unit square and glue parallel sides of equal length of the resulting polygon together, or, equivalently, glue facing sides of an L-shaped polygon (which amounts to cutting out the  $a \times b$  rectangle at the top right corner of the unit square).

**Lemma 8.** *Assume that  $a = p/q$ ,  $b = r/s$  are rational and belong to  $\mathcal{E}$ . Then the surface  $Y_{a,b}$  contains a dense set of one-cylinder directions with  $E$  and  $F$  on the waist curve of the cylinder.*

*Definition.* In the sequel, we will call *good one-cylinder direction* a one-cylinder direction with  $E$  and  $F$  on the waist curve of the cylinder.

*Proof.* We first prove that there exists one good one-cylinder direction. We rescale the surface, horizontally by  $q$  and vertically by  $s$ , to make it a primitive square-tiled surface. The surface  $Y_{a,b}$  becomes the L-shaped surface  $L(p, q - p, r, s - r)$ . As  $p, r, q - p, s - r$  are odd, this surface belongs to the orbit A (defined in subsection 2.3).

Moreover, as C. McMullen pointed out to us, Weierstrass points of a surface in orbit A have the following property: 3 regular Weierstrass points project to the same point of the torus, the singularity projects to the origin of the torus, the two remaining Weierstrass points project to the two other Weierstrass points of the torus. This gives a way to distinguish intrinsically these last 2 Weierstrass points. This property is  $SL_2(\mathbb{Z})$  invariant. It is known as Kani's invariant. McMullen (see [Mc] Appendix A) proves that, for a one-cylinder decomposition, the points on the waist curve of the cylinder are the 2 distinguished Weierstrass points. Therefore, it is enough for us to check that the regular Weierstrass points  $A, B, C$  project to the same point on the torus, which is true, since  $p, r, q - p$ , and  $s - r$  being odd, these points project to  $(1/2, 1/2)$  on the torus. Consequently  $E$  and  $F$  belong to the waist curve of *every* one-cylinder decomposition.

Now, we prove the density. The image of a one-cylinder direction under an affine map is a one-cylinder direction. Moreover the orbit of any point of  $P^1(\mathbb{R})$  under a lattice in  $SL_2(\mathbb{R})$  is dense in  $P^1(\mathbb{R})$ . Therefore the set of good one-cylinder directions is dense in the circle.  $\square$

*Remark 9.* Using the same method, we can prove that if the parameters  $(a, b)$  belong to  $\mathbb{Q} \times \mathbb{Q} \setminus \mathcal{E}$ , then  $Y_{a,b}$  has no good one-cylinder direction.

### 3.3. Periodic orbits on $X_{a,b}$ .

**Lemma 10.** *Good one-cylinder directions  $Y_{a,b}$  are strongly parabolic for  $X_{a,b}$ . In such a direction, the length of a periodic orbit on  $X_{a,b}$  is twice the length of its projection on  $Y_{a,b}$ .*

*Remark 11.* The proof has a fair amount in common with the proof of a similar result for  $\mathbb{Z}$ -covers of compact translation surfaces which appears in Hubert-Schmithüsen [HuSc].

*Proof.* Let  $\theta$  be a good one-cylinder direction on  $Y_{a,b}$ . In  $Y_{a,b}$ , every non singular orbit of direction  $\theta$  is a translate of the orbit of  $E$ . Thus any non singular trajectory on  $X_{a,b}$  in direction  $\theta$  is a translate of the orbit of some preimage of  $E$  (they belong to the same strip). Thus it is enough to prove that the orbit of every preimage of  $E$  on  $X_{a,b}$  is closed and to compute its length (in fact, since the table  $T_{a,b}$  is periodic, the proof the orbit of one preimage of  $E$  is enough).

We use the billiard flow for this proof instead of the linear flow because it seems to be more simple.

**Claim 12.** Let  $\alpha$  be any direction other than horizontal or vertical,  $\phi$  the flow in direction  $\alpha$ ,  $\hat{E}$  a preimage of  $E$  in  $T_{a,b}$ ,  $\hat{F}$  a preimage of  $F$  in  $T_{a,b}$ . Then, for each  $t$ ,  $\phi_t(\hat{E})$  and  $\phi_{-t}(\hat{E})$  are symmetric with respect to the vertical line containing  $\hat{E}$ , and  $\phi_t(\hat{F})$  and  $\phi_{-t}(\hat{F})$  are symmetric with respect to the horizontal line containing  $\hat{F}$ .

See Figure 5 for the position of points  $\hat{E}$ ,  $\hat{F}$ ,  $\tilde{E}$ ,  $\tilde{F}$ . (The figures in the appendix provide more examples of trajectories.)

As  $\hat{E}$  belongs to a horizontal side, before the first reflection on the boundary, the result is certainly true. Now, as the table is symmetric with respect to the vertical line containing  $\hat{E}$ , the trajectories in positive and negative time remain symmetric forever. The proof is similar for  $\hat{F}$ , so the claim is proved.

*Remark 13.* Consider a good one-cylinder direction for  $Y_{a,b}$ ; recall that this means  $Y_{a,b}$  decomposes into a single cylinder, whose waist curve

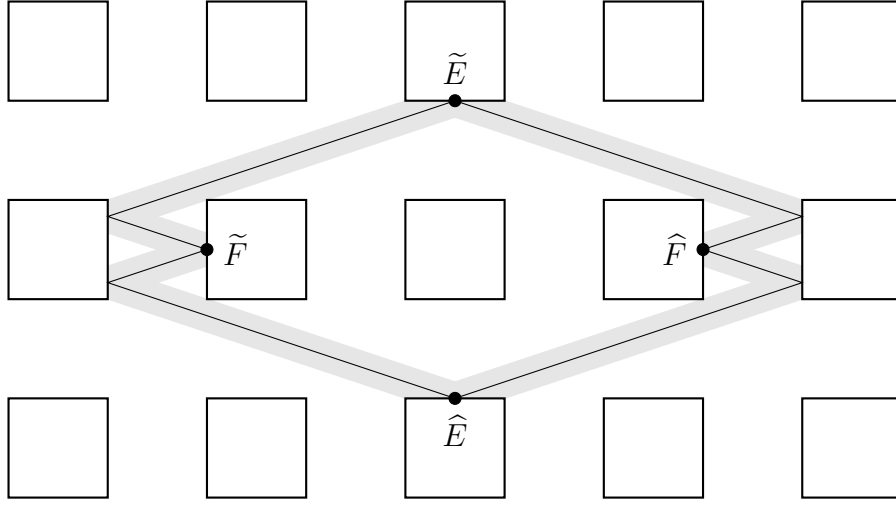

FIGURE 5. Points  $\hat{E}$ ,  $\hat{F}$ ,  $\tilde{E}$ ,  $\tilde{F}$  on a periodic trajectory starting from  $\hat{E}$ .

contains  $E$  and  $F$ . If  $\ell$  is the length of the cylinder, after flowing during time  $\ell/2$  from  $E$  we reach  $F$ .

We have all the ingredients to prove Lemma 10. Call  $(x, y)$  the coordinates of  $\hat{E}$ . From the previous remark,  $\phi_{\ell/2}(\hat{E})$  is a preimage  $\hat{F}$  of  $F$  with coordinates  $(u, v)$ . By claim 12,  $\phi_{\ell}(\hat{E}) = (x, 2v - y)$ . Since  $\phi_{\ell}(\hat{E}) = \phi_{\ell/2}(\hat{F})$ , using once more the remark,  $\phi_{\ell}(\hat{E})$  is a preimage  $\tilde{E}$  of  $E$ . By claim 12 again,  $\phi_{3\ell/2}(\hat{E}) = (2x - u, v)$ . Continuing the same way,  $\phi_{3\ell/2}(\hat{E})$  is  $\tilde{F}$  a preimage of  $F$ . Applying the symmetry argument,

$$\phi_{2\ell}(\hat{E}) = (x, 2v - (2v - y)) = (x, y) = \hat{E}.$$

We have to check that the outgoing vectors at  $\hat{E}$  at times 0 and  $2\ell$  have the same direction. Let  $\varepsilon$  be small enough. Once more, using the symmetry argument for  $\tilde{E}$ , we see that  $\phi_{\varepsilon}(\hat{E})$  and  $\phi_{2\ell-\varepsilon}(\hat{E})$  are symmetric with respect to the vertical line containing  $\hat{E}$  and  $\tilde{E}$ . As  $\hat{E}$  is on a horizontal boundary,  $\phi_{2\ell+\varepsilon}(\hat{E})$  and  $\phi_{2\ell-\varepsilon}(\hat{E})$  are symmetric with respect to this line. Thus  $\phi_{2\ell+\varepsilon}(\hat{E}) = \phi_{\varepsilon}(\hat{E})$ . This exactly means that the trajectory is closed.

We then remark that the length cannot be less than  $2\ell$ . It is a multiple of  $\ell$  since it is  $\ell$  on  $Y_{a,b}$ . We already note that  $\hat{E}$  and  $\tilde{E}$  are symmetric with respect to the vertical line containing  $\hat{F}$ . As the  $y$ -coordinate of any preimage of  $F$  differs from the  $y$  coordinate of  $\hat{E}$ , then  $\hat{E}$  and  $\tilde{E}$  are different. Therefore the trajectory of  $\hat{E}$  has length  $2\ell$  and the proof of Lemma 10 is complete.  $\square$

Lemmas 8 and 10 prove the first point of Theorem 4. We shall now prove the remark stated after Theorem 4, and then its second point.

### 3.4. Proof Remark 5.

**Lemma 14.** *Let  $(a, b) \in (0, 1)^2$ , and label by  $A, B, C, D, E, F$  the Weierstrass points of  $Y_{a,b}$  as on Figure 2. Let  $\gamma$  be a regular trajectory on  $Y_{a,b}$  containing two of the Weierstrass points  $A, B, C$ . Then any lift to  $X_{a,b}$  of  $\gamma$  has infinite length (it is not a closed trajectory on  $X_{a,b}$ ).*

*Proof of Lemma.* Let  $\gamma$  be a closed geodesic on  $Y_{a,b}$  containing  $A$  and  $B$ , and let  $\hat{\gamma}$  be a corresponding billiard trajectory on  $T_{a,b}$  (i.e.  $\hat{\gamma}$  unfolds to a lift of  $\gamma$  on  $X_{a,b}$ ).

Call  $A_0$  and  $B_0$  two points on  $\hat{\gamma}$  which correspond to  $A$  and  $B$ . Since the billiard trajectory goes through  $A_0$  and  $B_0$  in straight line (there is no reflection at these points) and since these points are centers of symmetry for  $T_{a,b}$ ,  $\hat{\gamma}$  also has  $A_0$  and  $B_0$  as centers of symmetry; therefore it is infinite.  $\square$

Recall that the Veech group of the surface  $Y_{1/2,1/2}$  is generated by  $\begin{pmatrix} 1 & 2 \\ 0 & 1 \end{pmatrix}$  and  $\begin{pmatrix} 0 & -1 \\ 1 & 0 \end{pmatrix}$ . Hence it has two cusps. One-cylinder directions have slope  $n/m$  with  $n, m$  odd, the other rational directions correspond to periodic directions with 2 cylinders. As  $(1/2, 1/2)$  belong to  $\mathcal{E}$ , one-cylinder directions lift to periodic directions on  $X_{1/2,1/2}$ . To prove Remark 5, it now suffices to prove that in any two-cylinder direction for  $Y_{1/2,1/2}$ , there is a regular geodesic on  $X_{1/2,1/2}$  connecting a lift of  $A$  and a lift of  $B$ .

One more lemma helps with this.

**Lemma 15.** *The orbits of the Weierstrass points of  $Y_{1/2,1/2}$  under its affine group are  $\{A, B, C\}$ ,  $\{D\}$ ,  $\{E, F\}$ .*

The proof is immediate, by looking at the action of  $\begin{pmatrix} 1 & 2 \\ 0 & 1 \end{pmatrix}$  and  $\begin{pmatrix} 0 & -1 \\ 1 & 0 \end{pmatrix}$  which generate the Veech group. (The affine group is isomorphic to the Veech group for surfaces in  $\mathcal{H}(2)$ .)

Now let  $\theta = u/v$  be a two-cylinder direction for  $Y_{1/2,1/2}$ ; then  $(v, u)$  is the image of  $(1, 0)$  under some element of the Veech group  $\text{SL}(X_{1/2,1/2})$ . Let  $f$  be the corresponding element in  $\text{Aff}(Y_{1/2,1/2})$ .

Since in the horizontal direction there is a geodesic on  $Y_{1/2,1/2}$  connecting  $A$  and  $B$ , in direction  $\theta$  there is a geodesic on  $Y_{1/2,1/2}$  connecting  $f(A)$  and  $f(B)$ , which are two points among  $A, B, C$ , by Lemma 15. We conclude by Lemma 14.

**3.5. Recurrence. Proof of Theorem 4.** We prove the second statement of Theorem 4: if  $(a, b) \in \mathcal{E}$ , the linear flow is recurrent on  $X_{a,b}$  for almost every irrational direction.

We first recall a famous theorem by Sullivan [Su], stated below in a weak form sufficient for our needs.

**Theorem** (Sullivan). *Let  $\Gamma$  be a finite-index subgroup of  $\mathrm{SL}(2, \mathbb{Z})$  and  $T$  a cusp of  $\Gamma$ , i.e. a  $\Gamma$ -orbit in  $\mathbb{Q} \cup \{\infty\}$ . Then for every  $\kappa > 0$  there exists a subset  $\Theta_\kappa$  of  $\mathbb{R}$  of full measure satisfying: for any  $\theta \in \Theta_\kappa$ , there exists an infinite sequence of rationals  $(p_n/q_n) \in T$  such that*

$$\left| \theta - \frac{p_n}{q_n} \right| \leq \frac{\kappa}{q_n^2}.$$

This is relevant to our setting because the set  $P$  of strongly parabolic directions for  $X_{a,b}$  contains all good one-cylinder directions for  $Y_{a,b}$ , hence it contains at least a cusp of the Veech group of  $Y_{a,b}$ , which is a finite-index subgroup in  $\mathrm{SL}(2, \mathbb{Z})$ .

Assuming, without loss of generality, that the slope is less than 1, Sullivan's theorem can be rephrased in the following way. Given a sequence  $\varepsilon_n \rightarrow 0$ , there exists a subset  $\Theta \subset [0, 1]$  of full measure such that if  $\theta$  belongs to  $\Theta$ , there exists an infinite sequence of rationals  $(p_n/q_n) \in P$  such that

$$\left| \theta - \frac{p_n}{q_n} \right| \leq \frac{\varepsilon_n}{q_n^2}.$$

**Lemma 16.** *Given a (finite-area) square-tiled surface  $S$ , there exists a constant  $K$  such that for every reduced rational  $p/q \in (0, 1]$ , cylinders in direction  $p/q$  on  $S$  have length at most  $Kq$  and height at least  $1/Kq$ . (If  $S$  is tiled by unit squares, then  $K$  depends only on the area of  $S$ .)*

*Proof.* On the torus, the cylinder in direction  $p/q$  has length  $\sqrt{p^2 + q^2}$  and height  $1/\sqrt{p^2 + q^2}$ ; assuming  $p/q \leq 1$ ,  $\sqrt{p^2 + q^2} \leq \sqrt{2} \cdot q$ . Letting  $d$  denote the number of squares of  $S$ , cylinders in direction  $p/q$  on  $S$  have length at most  $d \cdot \sqrt{2} \cdot q$  and height at least  $1/\sqrt{2}q$ , which is no less than  $1/d\sqrt{2}q$ .  $\square$

For a direction  $p/q \in P$ , we proved that lifts to  $X_{a,b}$  of cylinders on  $Y_{a,b}$  have double length and same height, so Lemma 16 still holds for  $X_{a,b}$  for directions in  $P$ .

Let  $R = R_{a,b}^{0,0}$  be the rectangle centered at the origin. Fix  $\theta \in \Theta$ , we want to prove that almost every orbit starting from the boundary of  $R$  comes back to  $R$ . This claim implies that the first return map on  $R$  is defined almost everywhere. As it is a set of finite measure, by Poincaré recurrence Theorem, this map is recurrent. Then, by  $\mathbb{Z}^2$  periodicity,

the flow in direction  $\theta$  is recurrent in the table  $T_{a,b}$ . Thus, it is enough to prove the claim.

Let  $p_n/q_n \in P$  such that

$$\left| \theta - \frac{p_n}{q_n} \right| \leq \frac{\varepsilon_n}{q_n^2}.$$

The boundary of the rectangle  $R$  intersects transversally a finite number of cylinders in direction  $p_n/q_n$ . All these cylinders being isometric, say of height  $h$ , they partition any side of  $R$  into a finite number of subintervals of equal length greater than  $h$ . By Lemma 16,  $h \geq 1/Kq_n$ . Calling  $J$  one of these intervals, and flowing in direction  $\theta$  starting in  $J$ , then after a time essentially equal to the length of the cylinder, the trajectory crosses  $J$  again, unless it leaves the cylinder before (see Figure 6).

The subinterval  $B$  of  $J$  consisting of points whose trajectories leave the cylinder before returning to  $J$  has measure at most the length of the cylinder times the difference between slopes  $\theta$  and  $p_n/q_n$ . By Lemma 16 and the assumption on  $p_n/q_n$  it is therefore at most  $Kq_n \times \varepsilon_n/q_n^2$ , i.e.  $K\varepsilon_n/q_n$ . Since the length of  $J$  has been seen to be at least  $1/Kq_n$ , the number of intervals like  $J$  on  $\partial R$  is at most  $\ell Kq_n$  where  $\ell = 2a + 2b$  is the perimeter of  $R$ . Thus, the measure of the points that do not return to  $R$  is bounded above by  $\ell K^2\varepsilon_n$ . Since  $\varepsilon_n \rightarrow 0$ , almost every point returns to  $R$ . This ends the proof of Theorem 4.  $\square$

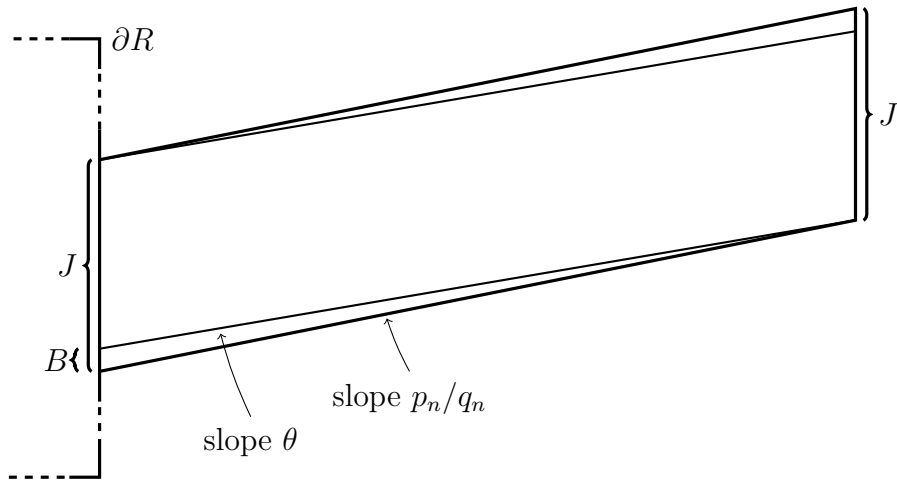

FIGURE 6. Recurrence. Trajectories in direction  $\theta$  run along the cylinder from  $J$  in direction  $p_n/q_n$  once unless they are in subinterval  $B$ , which has length  $\leq K\varepsilon_n/q_n$ .

#### 4. PROOF OF THEOREM 6

*Proof.* Suppose  $a = p/q$  and  $b = r/s$  with  $p$  and  $r$  even. Note that this implies  $q$  and  $s$  are odd, and thus the surface  $Y_{a,b}$  has an odd number of squares.  $E$  and  $F$  are integer Weierstrass points on  $Y_{a,b}$  because  $p$  and  $r$  are even. If either  $E$  or  $F$  is on the waist line of a cylinder, this cylinder has even area. Therefore neither  $E$  nor  $F$  can lie on the waist line of a cylinder in a one-cylinder decomposition of  $Y_{a,b}$ . Furthermore,  $E$  and  $F$  cannot lie on the waist lines of two distinct cylinders in a two-cylinder decomposition of  $Y_{a,b}$ . It follows that in any rational direction,  $Y_{a,b}$  has a cylinder with two of the points  $A, B, C$  on its waist line. By Lemma 14, we conclude that in any rational direction there is a strip on  $X_{a,b}$ .

The second point of the theorem is immediate: there are directions in which  $Y_{a,b}$  has only one cylinder; since these directions are not completely periodic, this means that this cylinder of  $Y_{a,b}$  lifts to infinite strips on  $X_{a,b}$ ; since this cylinder fills  $Y_{a,b}$  these strips fill  $X_{a,b}$ , which means there is no periodic trajectory on  $X_{a,b}$ . This set of directions is dense and denoted by  $P'$  in the sequel.

The proof of the third part has a similar structure to the proof of Theorem 4. Without loss of generality, we assume that the slope is less than 1. As we proved that  $P'$  contains at least a cusp of the Veech group of  $Y_{a,b}$  we can apply Khinchin-Sullivan's Theorem ([Su]), which states:

Let  $\phi : \mathbb{N} \rightarrow \mathbb{R}^+$  be a function with  $(q\phi(q))$  non increasing and  $\sum_{q=1}^{\infty} \phi(q) = \infty$ . There exists a subset  $\Theta$  of  $[0, 1]$  of full measure satisfying: if  $\theta$  belongs to  $\Theta$ , there exists a sequence of rationals  $(p_n/q_n) \in P'$  such that

$$|q_n\theta - p_n| \leq \phi(q_n).$$

Now, let  $k \in \mathbb{N}$  and  $f_k : x \mapsto \prod_{j=1}^k \log_j x$ ,  $\phi : x \mapsto \varepsilon(x)/(xf_k(x))$  where  $\varepsilon(x)$  tends to zero as  $x$  tends to infinity and is chosen so that  $\sum_{v=1}^{\infty} \phi(v) = \infty$ . For instance, one can choose  $\varepsilon(x) = \frac{1}{\log_{k+1} x}$ .

By Lemma 16, there is a constant  $K$  such that for every  $u/v \in P' \cap [0, 1]$ , cylinders in direction  $u/v$  on  $Y_{a,b}$  have length at most  $Kv$  and height at least  $1/Kv$ .

Let  $R = R_{a,b}^{0,0}$  be the rectangle centered at the origin. Fix  $\theta \in \Theta$ , we want to prove that almost every orbit starting from the boundary of  $R$  satisfies  $\limsup_{n \rightarrow \infty} \text{dist}(\phi_t^\theta x, x) / \prod_{j=1}^k \log_j t = \infty$ . It is enough to prove this claim by  $\mathbb{Z}^2$  periodicity.

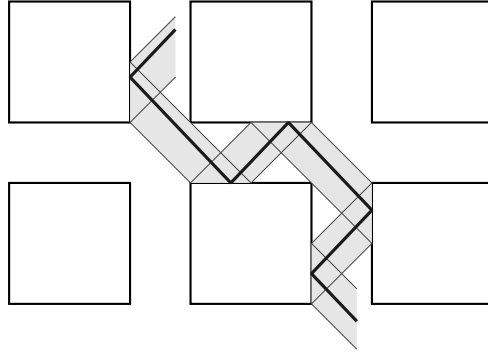

FIGURE 7. Close to an escaping rational direction. Here, a slope close to 1, with  $a = b = 2/3$ .

Let  $p_n/q_n \in P'$  such that

$$\left| \theta - \frac{p_n}{q_n} \right| \leq \frac{\varepsilon_n}{q_n^2 f_k(q_n)}.$$

Since a strip on  $T_{a,b}$  in direction  $p_n/q_n$  corresponds to a cylinder on  $Y_{a,b}$ , following such a strip for one period  $T$  amounts to a translation of some vector  $(m_1, m_2) \in \mathbb{Z}^2 \setminus (0, 0)$  and we have  $\text{dist}(\phi_T^{p_n/q_n} x, x) = \sqrt{m_1^2 + m_2^2} \geq 1$ . Note that  $T$  is of the order of  $Kq_n$  up to multiplicative constant.

The boundary of the rectangle  $R$  intersects transversally a finite number of strips in direction  $p_n/q_n$ . This partitions  $\partial R$  into a finite number of intervals.

Call  $J$  one of these intervals, we approximate the flow  $\phi^\theta$  in direction  $\theta$  by the flow  $\phi^{p_n/q_n}$ . Call  $S_{p_n/q_n}$  the strip in direction  $p_n/q_n$  containing  $J$ . While a trajectory of  $\phi^\theta$  stays in the strip  $S_{p_n/q_n}$ , it hits translates of  $J$  by multiples of  $(m_1, m_2)$  at times multiples of some  $T'$  close to  $T$  (to be more precise,  $|T' - T| \leq h$  where  $h$  is the height of the strip).

The subinterval  $B$  of  $J$  consisting of points whose trajectories in direction  $\theta$  escape the strip in direction  $p_n/q_n$  before hitting the first translate of  $J$  has measure at most  $K\varepsilon_n/q_n f_k(q_n)$  (this mimicks the proof of Theorem 4).

Similarly, the subinterval  $B_m$  of  $J$  consisting of points whose trajectories in direction  $\theta$  escape the strip  $S_{p_n/q_n}$  in direction  $p_n/q_n$  before hitting the  $m$ -th translate of  $J$  has measure at most  $mK\varepsilon_n/q_n f_k(q_n)$ .

For  $x \in J \setminus B_m$ , we have

$$(*) \quad \text{dist}(\phi_{mT'}^\theta x, x) \geq m$$

Thus for  $m = \lfloor f_k(q_n) \rfloor$ ,  $B_m$  has measure at most  $K\varepsilon_n/q_n$ .

As the length of  $J$  is at least the height of a cylinder in direction  $\frac{p_n}{q_n}$ ,  $|J| \geq 1/Kq_n$ . Consequently, the number of such intervals  $J$  is at most  $\ell Kq_n$ , where  $\ell = 2a + 2b$  as in the proof of Theorem 4. Thus, the measure of the points of  $R$  that do not satisfy  $(*)$  with  $m = \lfloor f_k(q_n) \rfloor$  is bounded above by  $\ell K^2 \varepsilon_n$  which tends to 0.  $\square$

## 5. PROOF OF COROLLARY 3

In this section, we prove Corollary 3. We start with two easy lemmas.

**Lemma 17.** *The sets  $\mathcal{E}$  and  $\mathcal{E}'$  are both dense in  $[0, 1] \times [0, 1]$ .*

*Proof.* To prove that  $\mathcal{E}$  is dense in  $[0, 1] \times [0, 1]$ , it is enough to show that the set

$$\Sigma = \left\{ p/q \in \mathbb{Q} : 0 < p < q, \quad p \text{ odd}, \quad q \text{ even} \right\}$$

is dense in  $\mathbb{Q} \cap [0, 1]$ . Let  $a$  and  $b$  integers with  $(a, b) = 1$ . If  $a/b$  is a rational in  $[0, 1]$ . If  $a, b$  odd, the sequence  $\left(\frac{(2k+1)a}{(2k+1)b+a}\right)$  of elements in  $\Sigma$  tends to  $a/b$ . If  $a$  is even and  $b$  odd then the sequence  $\left(\frac{2ka}{2kb+a}\right)$  of elements in  $\Sigma$  tends to  $a/b$ . Thus the density is proven. Essentially by the same proof, the set

$$\Sigma' = \left\{ p/q \in \mathbb{Q} : 0 < p < q, \quad p \text{ even}, \quad q \text{ odd} \right\}$$

is dense in  $\mathbb{Q} \cap [0, 1]$ , thus  $\mathcal{E}'$  is dense in  $[0, 1] \times [0, 1]$ .  $\square$

**Lemma 18.** *For any  $0 < \epsilon < 1$ , there is a finite set  $E_\epsilon$  such that if  $\min(a, b) \geq \epsilon$  then every billiard trajectory in  $T_{a,b}$  of slope  $\theta \notin E_\epsilon$  has collisions.*

*Proof.* Trajectories of irrational slopes have collisions, since linear flows of irrational slopes on the standard torus are minimal. The lemma then follows from the fact that trajectories of rational slope  $u/v$  are  $\delta$ -dense with  $\delta = 1/\sqrt{u^2 + v^2}$ .  $\square$

**Proof of Corollary 3.** For each parameter value, call the rectangle centered at the origin the *base rectangle*. Let  $V_{a,b}$  denote the phase space of the billiard map  $\phi_{a,b}$  restricted to the base rectangle, i.e.  $V_{a,b}$  is the direct product of boundary of the base rectangle with all inward pointing unit vectors.

We will first prove, by approximating by tables from the set  $\mathcal{E} \cap \mathcal{Y}$ , that there is a dense  $G_\delta$  set of tables satisfying the first two points of the corollary.

**Claim.** Fix a sequence  $\varepsilon_n \rightarrow 0$ . For each  $(a, b) \in \mathcal{E} \cap \mathcal{Y}$  and each  $n \geq 1$ , we can choose a small open neighborhood  $O(a, b, n)$  of  $(a, b)$  such that for all  $(a', b') \in O(a, b, n)$ ,

- i) at least a proportion  $(1 - \varepsilon_n)$  of the points in  $V_{a',b'}$  recur to  $V_{a',b'}$ ,
- ii) and the set of periodic points in  $V_{a',b'}$  is at least  $\varepsilon_n$ -dense.

First we show how the first two points of the corollary follow from the claim. For each  $n \geq 1$  the set  $O_n = \bigcup_{(a,b) \in \mathcal{E} \cap \mathcal{Y}} O(a, b, n)$  contains  $\mathcal{E} \cap \mathcal{Y}$  and thus is dense in  $\mathcal{Y}$ . Since  $O_n$  is clearly open, the set  $\bigcap_{m=1}^{\infty} \bigcup_{n=m}^{\infty} O_n$  is residual in  $\mathcal{Y}$ . For any parameter  $(a', b')$  in this set the set of periodic points in  $V_{a',b'}$  are  $\varepsilon_n$  dense for infinitely many  $n$ , i.e. they are dense in  $V_{a',b'}$ . Furthermore for infinitely many  $n$ , a proportion  $(1 - \varepsilon_n)$  of the points in  $V_{a',b'}$  recur to  $V_{a',b'}$ , i.e. a.e. point in  $V_{a',b'}$  recurs to  $V_{a',b'}$ . Since our tables are  $\mathbb{Z}^2$  periodic, these two results hold throughout the phase space, i.e. periodic points are dense in the whole phase space (the second point of the corollary) and a.e. point in a given rectangle recurs to that rectangle. Thus for any fixed rectangle, we can define almost everywhere a first return map to that rectangle. The first part of the corollary follow by applying the Poincaré recurrence theorem and the Fubini theorem to this map.

There remains to prove the claim. Consider two parameter values  $(a_1, b_1)$  and  $(a_2, b_2)$ . The corresponding base rectangles have corners at  $(\pm a_i/2, \pm b_i/2)$ . Throughout the rest of the proof we will identify parts of the boundaries of the base rectangles as follows:  $(a_1, x)$  will be identified with  $(a_2, x)$  for all  $x$  satisfying  $|x| \leq \min(b_1, b_2)/2$ , and similarly for the other sides of the base rectangles. This gives a natural identification of the corresponding parts of the phase space  $V_{a,b}$ . This identification respects the structure of the invariant measure, thus it will be referred to as  $\mu$ , suppressing the parameter dependence.

Fix  $(a, b) \in \mathcal{E} \cap \mathcal{Y}$ . Let

$$O'(a, b, n) := \{(a', b') : \max(|a' - a|, |b' - b|) \leq \varepsilon_n/3\}.$$

Let  $A = A(a, b, n)$  denote the part, which under the identification described above, is common to  $V_{a',b'}$  for all the parameter values in  $O'(a, b, n)$ . For each  $(a', b') \in \mathcal{Y}$ , viewed as a subset of  $V_{a',b'}$ , the set  $A$  satisfies

$$(1) \quad \mu(A) \geq (1 - \varepsilon_n)\mu(V_{a',b'}) \text{ and } A \text{ is at least } \varepsilon_n\text{-dense in } V_{a',b'}.$$

Theorem 1 implies that i) and ii) hold for  $(a, b) \in \mathcal{E}$ . We need to extend this to an open neighborhood of parameter values. For the moment we place ourselves in  $V_{a,b}$ . We need to identify a “large” set of recurrent and periodic points for which the dynamics is identical for all  $(a', b')$  in some open neighborhood  $O(a, b, n)$  at the time of periodicity or recurrence.

To do this we will remove orbits which approach too close to a corner. Since  $\mathcal{Y}$  is closed, there is  $\epsilon > 0$  such that for all  $(a', b') \in \mathcal{Y}$ ,  $\min(a', b') \geq \epsilon$  and we remove from  $V_{a', b'}$  all  $(x, \theta)$  with  $\theta$  in a  $\delta_n$  neighborhood of the set  $E_\epsilon$  given by Lemma 18. Call the resulting set  $B \subset V_{a, b}$ . We choose  $\delta_n$  so small that

$$(2) \quad \mu(B \cap A) \geq (1 - \varepsilon_n)\mu(A) \text{ and } B \cap A \text{ is at least } \varepsilon_n \text{ dense in } A.$$

Recall that the combinatorial length of an orbit segment is the number of collisions it makes. Since we have removed a neighborhood of  $E_\epsilon$ , there exists a positive constant  $K_n$  (depending on  $\varepsilon_n$ ) such that the geometric length  $|o|_g$  and the combinatorial length  $|o|_c$  of any finite orbit segment satisfies  $|o|_g/|o|_c < K_n$  for sufficiently long orbit segments.

Let  $C_N$  be the set of points in  $B \cap A$  which recur to the base rectangle before time  $N$ . Note that periodic points recur at the time of their period. Theorem 1 implies that  $\mu(B \cap A \setminus \cup_{n \in \mathbb{N}} C_N) = 0$ . Thus we can choose  $N = N(a, b, n)$  so large that

$$(3) \quad \mu(C_N) \geq (1 - \varepsilon_n)\mu(B \cap A) \text{ and } C_N \text{ is at least } \varepsilon_n \text{ dense in } B \cap A.$$

The orbit segment of any point in  $C_N$  until it recurs to the base rectangle stays in a ball of radius  $K_n N$  centered at the origin. There are at most  $K'_n N^2$  rectangles in this neighborhood and thus at most  $K''_n N^2$  corners (for certain constants  $K'_n$  and  $K''_n$  which depends on  $\varepsilon_n$ ). Setting  $\gamma_n = \varepsilon_n / (N K''_n N^2)$ , the  $\gamma_n$ -neighborhood of the corners of all these rectangles has measure at most  $K''_n N^2 \gamma_n = \varepsilon_n / N$ . Consider the set  $D := \{x \in C_N : \text{there is no } 1 \leq i \leq N \text{ such that } \phi_{a, b}^i x \text{ is } \gamma_n\text{-close to a corner}\}$ . Then

$$(4) \quad \mu(D) \geq (1 - \varepsilon_n)\mu(C_N) \text{ and } D \text{ is at least } \varepsilon_n\text{-dense in } C_N.$$

Let  $\beta_n > 0$ ,  $(a', b')$  such that  $\max(|a' - a|, |b' - b|) \leq \beta_n$  and let  $x$  be a point such that the orbit of  $x$  has the same combinatorics (intersects the same rectangles) until the  $N$ th collision on the tables  $T_{a, b}$  and  $T_{a', b'}$ . We have:  $|\phi_{a, b}^k(x) - \phi_{a', b'}^k(x)| < K''' N \beta_n$  where  $K'''$  is a constant (this means that the orbits diverge at speed at most linear which is obvious). Take  $\beta_n$  so small that  $2N\beta_n \leq \gamma_n/2$ . Now take  $O(a, b, n) \subset O'(a, b, n)$  a small neighborhood of  $(a, b)$  given by  $O(a, b, n) := \{(a', b') : \max(|a' - a|, |b' - b|) \leq \beta_n\}$ . On the set  $D$ , the dynamics for any table  $(a', b') \in O(a, b, n)$  has the same combinatorics as the dynamics on the table  $(a, b)$ . In particular all recurrent points of  $D$  are recurrent for all parameter values.

To get the same result for periodic orbits, we need the following

**Lemma 19.** *Periodic orbits are stable under small perturbations of the parameters.*

*Proof.* Given a periodic orbit  $\gamma$  of slope  $\theta$  and combinatorial length  $N$  on  $T_{a,b}$ , we want to construct a periodic orbit  $\gamma'$  of the same combinatorial length on  $T_{a',b'}$  where  $(a',b')$  belongs to a small neighborhood of  $(a,b)$ . We also want the slope and the starting point of  $\gamma'$  to be close to those of  $\gamma$ .

The periodic orbit  $\gamma$  belongs to a cylinder  $\mathcal{C}$  of height  $2d$ . Without loss of generality, assume that  $\gamma$  is the waist curve of this cylinder.

See an unfolded view in Figure 8 and a billiard view in Figure 9.

Fix a starting point  $x$  for  $\gamma$  on a vertical side of a rectangle  $R = R_{a,b}^{i,j}$  and call  $x'$  the corresponding point on  $R' = R_{a',b'}^{i,j}$ . To get estimates, take  $\theta$  in the complement of a neighborhood of a set  $E_\epsilon$  given by Lemma 18. Take  $(a',b')$  close enough to  $(a,b)$  so that the orbits of  $x$  of slope  $\theta$  in  $T_{a,b}$  and of  $x'$  of same slope  $\theta$  in  $T_{a',b'}$  have the same combinatorics (exactly as in the proof of the previous lemma). We denote by  $O(a,b)$  this neighborhood and  $\delta$  its diameter.

Given an interval  $I$  on a vertical side of  $R$ , and given  $(a',b') \in O(a,b)$ , denote by  $I'$  its horizontal translate on the corresponding vertical side of  $R'$ . Call  $J$  the vertical segment of  $\partial R$  containing  $x$  such that for all  $(a',b') \in O(a,b)$ , orbits under  $\phi^\theta$  of all  $y' \in J'$  have the same combinatorics as  $\gamma$  for at least  $N$  collisions.

Denote by  $J_N$  and  $J'_N$  the segments obtained after  $N$  collisions starting in direction  $\theta$  from  $J$  in  $T_{a,b}$  and  $J'$  in  $T_{a',b'}$  respectively. For each  $(a',b') \in O(a,b)$  we consider the unfolding of combinatorial length  $N$  of the trajectory of the interval  $J$  in the direction  $\theta$ , and we call  $\widehat{J}_N$  and  $\widehat{J}'_N$  the lifts of  $J_N$  and  $J'_N$  in this unfolding. As already mentioned in the previous lemma,  $\widehat{J}'_N$  is translated from  $\widehat{J}_N$  by a vector of length at most  $\kappa N\delta$  where  $\kappa$  is a constant depending on the slope (uniform when  $\theta$  is not too close to the directions in  $E_\epsilon$ ). We choose  $\delta$  so small that  $\kappa N\delta < d/2$ . This choice of  $\delta$  guarantees that there is a lift  $z'$  of  $x'$  in  $\widehat{J}'_N$  (for all  $(a',b') \in O(a,b)$ ). Connect  $x'$  to  $z'$  by a straight line, this line will stay in the the strip of height  $d$  contained in the unfolding of the cylinder  $\mathcal{C}$  (see Figure 8). If  $\delta$  is small enough, no singularity enters this strip.  $\square$

Combining Equations (1)-(4) yields (after appropriate redefinition of the  $\varepsilon$ 's) our claim:

$$(5) \quad \mu(D) \geq (1 - \varepsilon_n)^4 \mu(V_{a',b'}) \text{ and } D \text{ is at least } 4\varepsilon_n \text{ dense in } V_{a',b'}$$

for all  $(a',b') \in O(a,b,n)$ .

Finally we will construct a dense  $G_\delta$  set of tables which satisfies the third point of the corollary. Fix a sequence  $\varepsilon_n \rightarrow 0$  and fix  $k \geq 1$ .

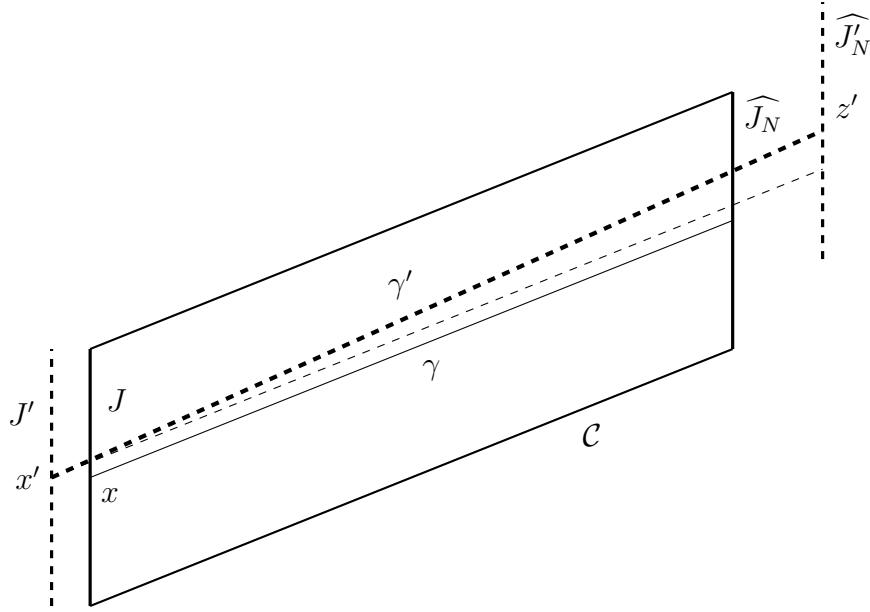

FIGURE 8. Stability of periodic orbits (unfolded view): the trajectory  $\gamma$  in direction  $\theta$  starting from  $x \in J$ , the trajectory from  $x' \in J'$  parallel to  $\gamma$ , and the periodic trajectory  $\gamma'$  from  $x'$  obtained by a small perturbation of the angle ( $z'$  and  $x'$  project to the same point in the billiard table  $T_{a',b'}$ ).

**Claim.** For each  $(a, b) \in \mathcal{E}' \cap \mathcal{Y}$  and each  $n \geq 1$  we can choose a small open neighborhood  $O(a, b, n)$  of  $(a, b) \in \mathcal{E}'$  such that, for  $(a', b') \in O(a, b, n)$ ,

- iii) there exists  $m = m(a, b, n, x)$  such that at least a proportion  $(1 - \varepsilon_n)$  of the points in  $V_{a',b'}$  satisfy  $\frac{\text{dist}(\phi_m^\theta x, x)}{\prod_{j=1}^k \log_j m} \geq n$ .

We next show that the corollary follows from the claim. For each  $n \geq 1$  the set  $O_n = \bigcup_{(a,b) \in \mathcal{E}' \cap \mathcal{Y}} O(a, b, n)$  contains  $\mathcal{E}' \cap \mathcal{Y}$  and thus is dense in  $\mathcal{Y}$ . Since  $O_n$  is clearly open the set  $\bigcap_{m=1}^{\infty} \bigcup_{n=m}^{\infty} O_n$  is residual in  $\mathcal{Y}$ .

For any parameter  $(a', b')$  in this set we have for a.e. point in  $V_{a',b'}$  for any infinite subsequence of  $n$ 's there are  $a = a(n)$ ,  $b = b(n)$  such that  $a', b' \in O(a, b, n)$  and there is  $m = m(a, b, n, x)$  such that  $\text{dist}(\phi_m^\theta x, x) / (\prod_{j=1}^k \log_j m) \geq n$  for a.e. point in  $V_{a',b'}$ . Since our tables are  $\mathbb{Z}^2$  periodic, there is a dense  $G_\delta$  of tables satisfying the third point

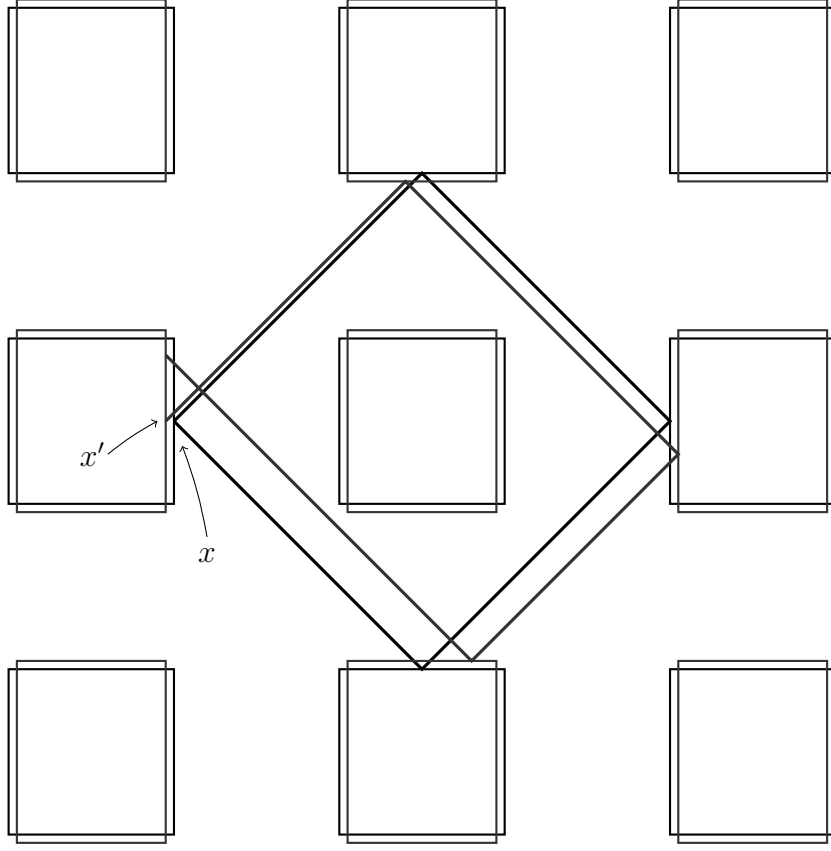

FIGURE 9. Stability of periodic orbits. The orbit from  $x'$  parallel to a periodic orbit starting from  $x$  ends near  $x'$  and hence can be made periodic by a small perturbation of the angle.

in the corollary. Since the intersection of two dense  $G_\delta$  sets is again a dense  $G_\delta$  the corollary follows.

There remains to prove the claim. Fix  $(a, b) \in \mathcal{E}' \cap \mathcal{Y}$  and define as above the sets  $O'(a, b, n)$ , and  $A = A(a, b, n)$ . Theorem 6 implies that iii) holds for  $(a, b) \in \mathcal{E}'$ . We need to extend this to an open neighborhood of parameter values. For the moment we place ourselves in  $V_{a,b}$ . As before we remove from  $A$  a  $\delta_n$  neighborhood of the set  $E_\epsilon$ , calling the resulting set  $B \subset V_{a,b}$ . We choose  $\delta_n$  so small that equation 2 is satisfied and choose  $K_n$  as before as well.

Let  $C_N$  be the set of points  $x \in B \cap A$  which satisfy iii) with  $m(a, b, n, x) \leq N$ . Theorem 6 implies that  $\mu(B \cap A \setminus \cup_{n \in \mathbb{N}} C_N) = 0$ . Thus we can choose  $N = N(a, b, n)$  so large that

$$(6) \quad \mu(C_N) \geq (1 - \varepsilon_n)\mu(B \cap A).$$

The orbit segment up to time  $m(a, b, n, x)$  of any point  $x \in C_N$  stays in a ball of radius  $K_n N$  centered at the origin. Defining  $D$  (the set of points in  $C_N$  whose orbits of length  $N$  stay sufficiently far away from corners to have the same symbolic orbit for all parameter values in  $O(a, b, n)$ ) in the identical way as above yields

$$(7) \quad \mu(D) \geq (1 - \varepsilon_n)\mu(C_N).$$

Combining Equations (1),(2),(6),(7) yields (after appropriate redefinition of the  $\varepsilon$ 's) our claim: for all  $(a', b') \in O(a, b, n)$ ,

$$(8) \quad \mu(D) \geq (1 - \varepsilon_n)^4 \mu(V_{a', b'}). \quad \square$$

## APPENDIX: A FEW PICTURES

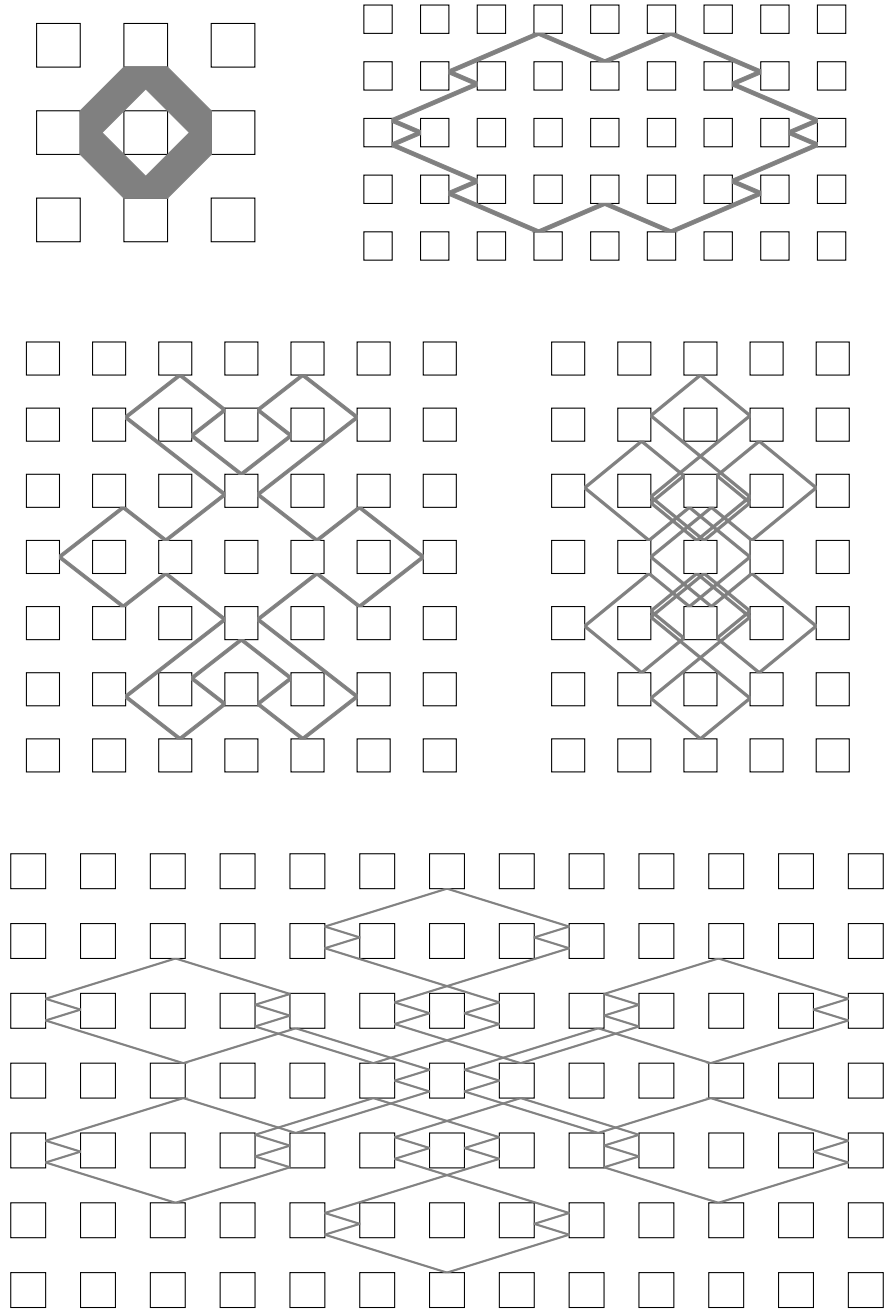

FIGURE 10. Obstacle size  $1/2 \times 1/2$ . Periodic trajectories: slopes 1,  $3/7$ ,  $7/9$ ,  $9/11$  and  $9/29$ .

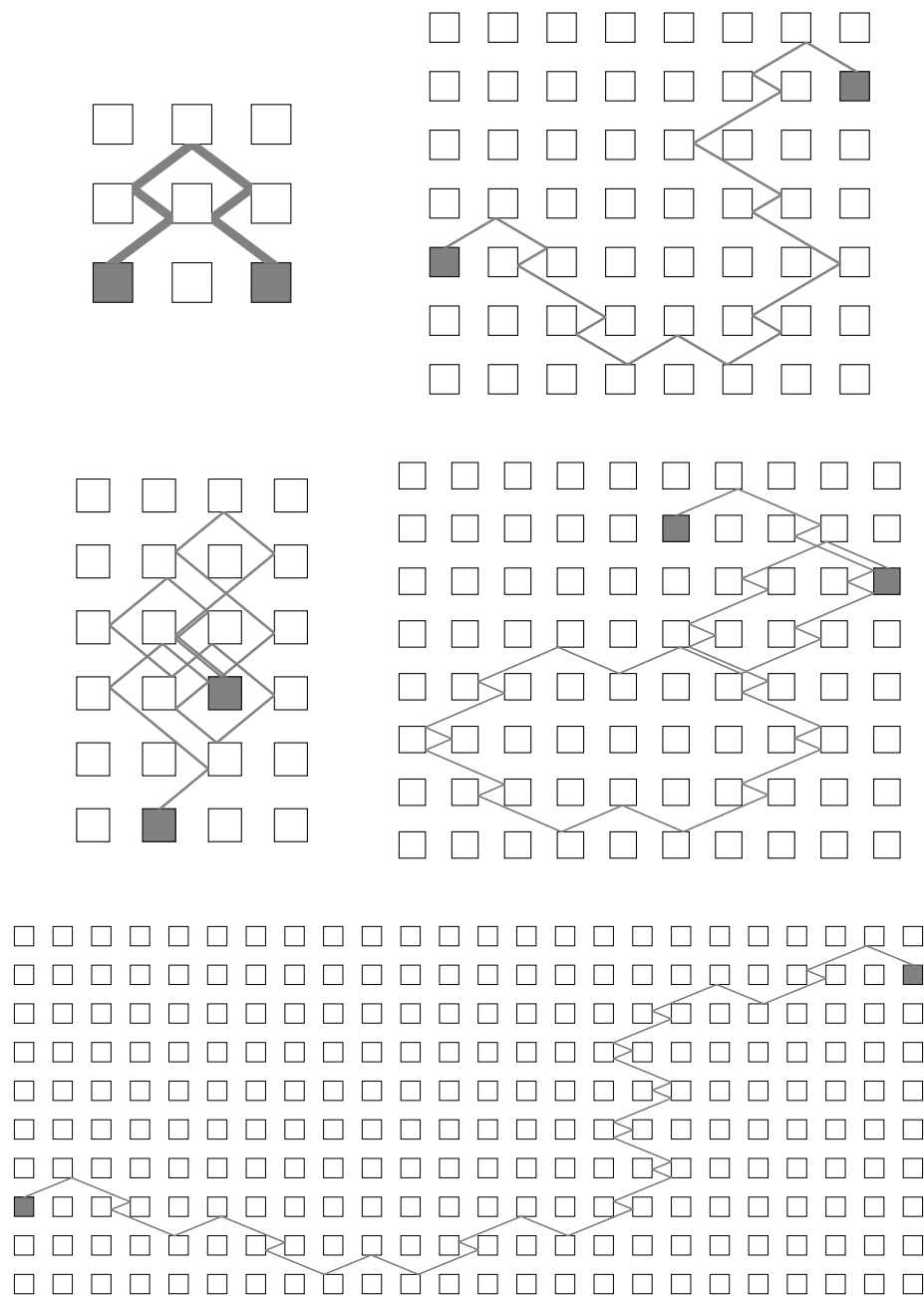

FIGURE 11. Escaping trajectories: slopes  $3/4$ ,  $10/17$ ,  $14/17$ ,  $16/37$ , and  $16/39$ , for obstacle size  $1/2 \times 1/2$ . The grayed obstacles are hit at the same location, so the trajectory repeats afterwards with a drift.

## REFERENCES

- [Bo] J. Bowman, *Flat structures and complex structures in Teichmüller theory*, Ph. D. thesis, Cornell University, (2009).
- [DDL] M. Degli Esposti, G. Del Magno, M. Lenci, *Escape orbits and ergodicity in infinite step billiards*, *Nonlinearity* 13 (2000), 1275–1292.
- [EhEh] P. and T. Ehrenfest, *Begriffliche Grundlagen der statistischen Auffassung in der Mechanik* Encykl. d. Math. Wissensch. IV 2 II, Heft 6, 90 S (1912) (in German, translated in:) *The conceptual foundations of the statistical approach in mechanics*, (trans. Moravicsik, M. J.), 10-13 Cornell University Press, Itacha NY, (1959).
- [GuTr] E. Gutkin and S. Troubetzkoy, *Directional flows and strong recurrence for polygonal billiards*, in Proceedings of the International Congress of Dynamical Systems, Montevideo, Uruguay, F. Ledrappier et al. eds. (1996) 21–45.
- [HaWe] J. Hardy, J. Weber, *Diffusion in a periodic wind-tree model*, *J. Math. Phys.* 21 (7),(1980) 1802–1808.
- [Ho] W. P. Hooper, *Dynamics on an infinite surface with the lattice property*, (2007) preprint.
- [HuLe] P. Hubert, S. Lelièvre, *Prime arithmetic Teichmüller discs in  $\mathcal{H}(2)$* , *Israel J. Math.* 151 (2006), 281–321.
- [HuSc] P. Hubert, G. Schmithüsen, *Infinite translation surfaces with infinitely generated Veech groups* (2009) preprint.
- [HuWe] P. Hubert, B. Weiss, *Dynamics on the infinite staircase*, (2008) preprint.
- [Ka1] E. Kani, *Hurwitz spaces of genus 2 covers of an elliptic curve*, *Collect. Math.* 54 (2003), no. 1, 1–51.
- [Ka2] E. Kani, *The number of genus 2 covers of an elliptic curve*, *Manuscripta Math.* 121 (2006), no. 1, 51–80.
- [MaTa] H. Masur, S. Tabachnikov, *Rational billiards and flat structures*, *Handbook of dynamical systems*, Vol. 1A, 1015–1089, North-Holland, Amsterdam, 2002.
- [Mc] C. McMullen, *Teichmüller curves in genus two: discriminant and spin*, *Math. Ann.* 333 no. 1, (2005) 87–130.
- [Su] D. Sullivan, *Disjoint spheres, approximation by imaginary quadratic numbers, and the logarithm law for geodesics*, *Acta Math.*, 149 (1982) 215-237.
- [Tr] S. Troubetzkoy, *Billiards in infinite polygons*, *Nonlinearity* 12 (1999) 513–524.
- [Tr1] S. Troubetzkoy, *Recurrence and periodic billiard orbits in polygons*, *Regul. Chaotic Dyn.* 9 (2004) 1–12.
- [Tr2] S. Troubetzkoy, *Periodic billiard orbits in right triangles*, *Annales de l’Inst. Fourier* 55 (2005) 29–46.
- [Ve] W. A. Veech, *Teichmüller curves in moduli space, Eisenstein series and an application to triangular billiards*, *Invent. Math.* 97 (1989), no. 3, 553–583.
- [Vi] M. Viana, *Dynamics of interval exchange maps and Teichmüller flows*, preprint.
- [Zo] A. Zorich, *Flat surfaces*, *Frontiers in number theory, physics, and geometry I*, 437–583, Springer, Berlin, 2006.

LABORATOIRE D'ANALYSE, TOPOLOGIE ET PROBABILITÉS, CASE COUR A,  
FACULTÉ DES SCIENCES DE SAINT-JERÔME, AVENUE ESCADRILLE NORMANDIE-  
NIEMEN, 13397 MARSEILLE CEDEX 20, FRANCE.

*E-mail address:* `hubert@cmi.univ-mrs.fr`

*URL:* `http://www.cmi.univ-mrs.fr/~hubert/`

LABORATOIRE DE MATHÉMATIQUE D'ORSAY, UMR 8628 CNRS / UNIVER-  
SITÉ PARIS-SUD 11, BÂTIMENT 425, CAMPUS ORSAY-VALLÉE, 91405 ORSAY  
CEDEX, FRANCE.

*E-mail address:* `samuel.lelievre@math.u-psud.fr`

*URL:* `http://www.math.u-psud.fr/~lelievre/`

CENTRE DE PHYSIQUE THÉORIQUE, FEDERATION DE RECHERCHES DES UNITES  
DE MATHÉMATIQUE DE MARSEILLE, INSTITUT DE MATHÉMATIQUES DE LUMINY  
AND, UNIVERSITÉ DE LA MÉDITERRANÉE, LUMINY, CASE 907, F-13288 MAR-  
SEILLE CEDEX 9, FRANCE

*E-mail address:* `troubetz@iml.univ-mrs.fr`

*URL:* `http://iml.univ-mrs.fr/~troubetz/`